

# Tub•Master "IT/IS" Folding Door Installation Instructions

**Read Instructions Completely Before Starting  
Installer: Leave this sheet with Homeowner**

**IMPORTANT: Silicone caulking not included.**

1. Measure the width of top and bottom openings (**A-1** and **A-2**) at the tub/shower curb. Subtract  $\frac{1}{4}$ " from this measurement to allow for wall jamb (#24) clearance.

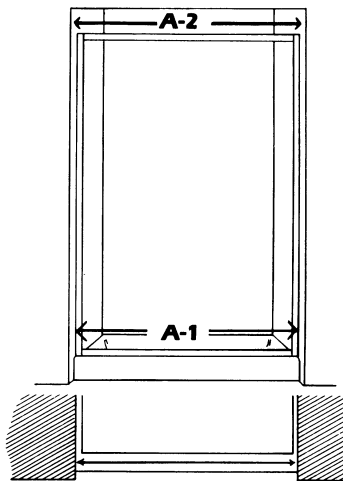

2. Cut bottom track, (#23) (**B-1**). Position track on the center of curb and mark walls at the ends of track (**B-2**). Remove bottom track.

NOTE: For doors less than 36", one (1) 72" track may be shipped with unit.

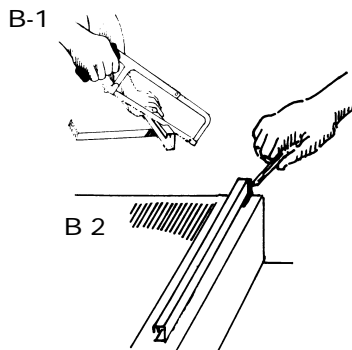

3. Align plastic wall jambs (#24) with the mark against either wall, seat firmly on tub/shower (file corner of jamb or remove some grout, if necessary, for a flush fit), and position vertically. Mark position of screw holes in each jamb (**C**) and repeat at opposite jamb.

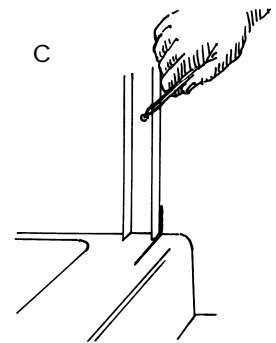

4. Remove wall jambs. Center punch the surface (**D-1**). Drill  $\frac{3}{16}$ " holes using masonry drill bit (**D-2**). Insert plastic plugs into the holes. Clean the shower area of drill dust using denatured alcohol and clean cloth.

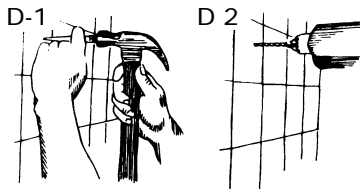

5. Apply two full length beads of silicone caulk to back of plastic wall jambs (**E-1**). Use a quality caulk such as G.E. Silicone™.

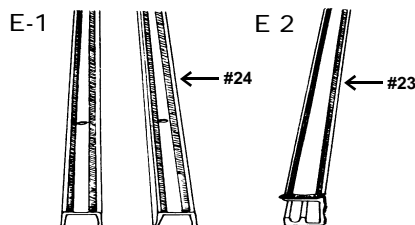

6. Fasten plastic wall jambs (#24) with screws (**F**).

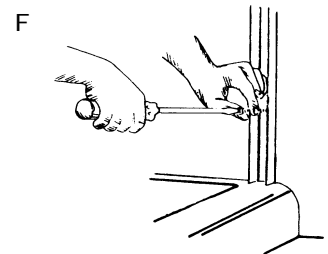

**IMPORTANT: For Questions or Missing Parts  
Contact Customer Service: 407-898-2881  
Monday - Friday, 8am-5pm EST**

# "IT/IS" Folding Door Installation Instructions

7. Apply silicone caulk to inside of wall jambs at bottom (**G**).

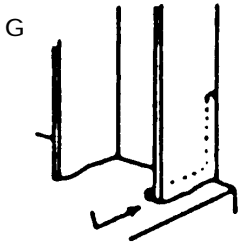

8. Apply silicone caulk generously under bottom track (**#23**) (**E-2**). Press bottom track into position between wall jambs (**H**).

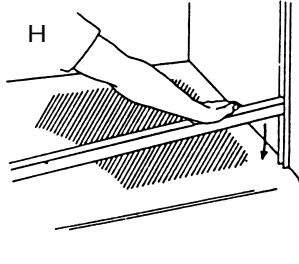

9. The fixed panel (**#1**) can go on either end of the shower, but it is recommended that it go to the end opposite the shower head. Insert the loose panel into the fixed panel snap jamb (**#62**) and fixed panel post (**#63**) (**I**).

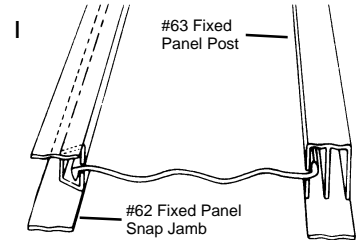

10. Snap the fixed panel assembly in place (**J**).

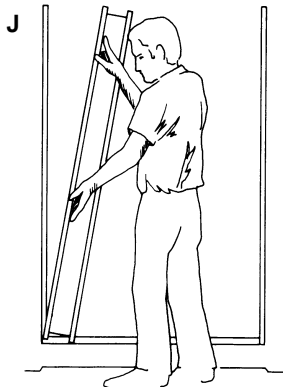

11. Measure width of opening at top of installed plastic wall jambs (**A-2**). Subtract 1/4" from this measurement and cut top track. Insert wedge lock (**#36**) at the end of the top track opposite the fixed panel (**K-1**). Insert the lock block (**#60**) in the fixed panel end (**K-2**).



12. Apply a bead of silicone caulk to the inside bottom of the fixed panel (**L**).

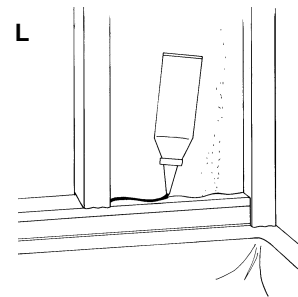

13. Remove panel stop roller bracket screw (**#6**) from the metal lead post at the fixed panel end. Place the wheel stop bracket (**#61**) over the roller and replace the screw (**M**).

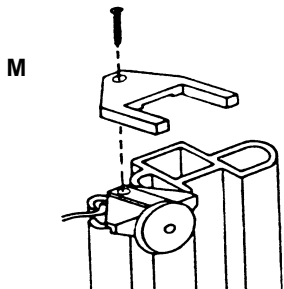

14. Hook the wheels of the door into the top track so the lock block is between the lead post and the first hinge with a wheel (**N-1**). Hold the door as shown (**N-2**).

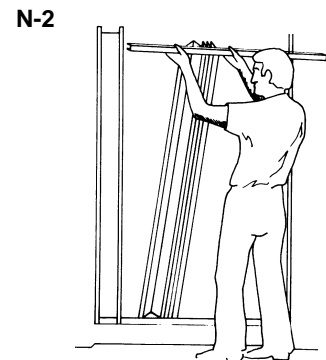
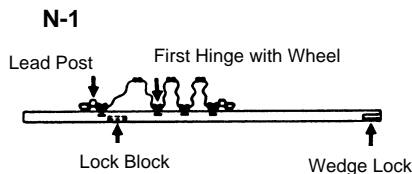

# "IT/IS" Folding Door Installation Instructions

15. Insert top track into the fixed panel snap jamb and post (O) and rest the other end of the top track on top of the plastic wall jamb.

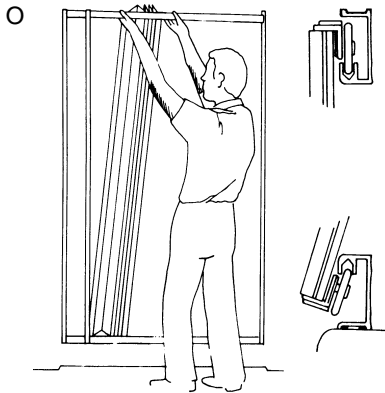

16. Snap the metal snap jamb (#25) over the plastic wall jamb (#24) (P).

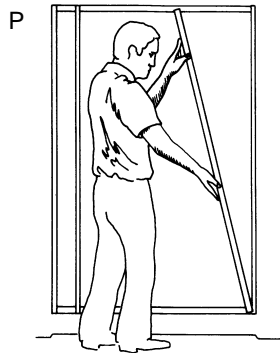

17. Extend the door to the wall opposite the fixed panel. Slide the lock block (#60) against the stop bracket (#61). Using a screw driver, tighten the cam to lock in place (Q).

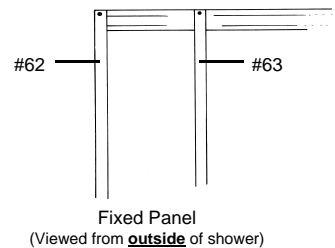
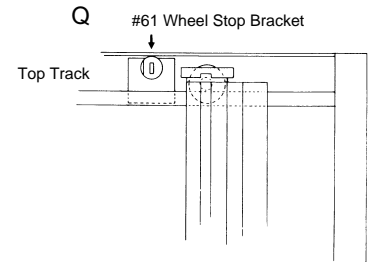

18. Install handle (#54) on the inside of the lead post on end opposite fixed panel and secure with the screw (#39) provided (R-1).

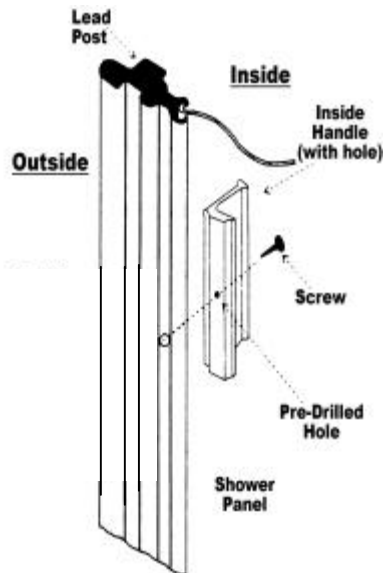

19. Optional Front Handle: Drill 7/64" hole in front of lead post, attach handle with screw provided approximately 1/2" above or below back handle (R-2).

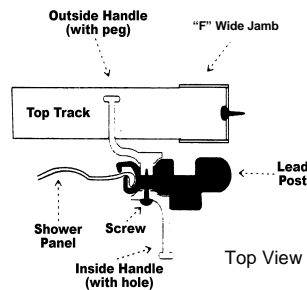

**IMPORTANT:** For smooth operation spray rollers with silicone spray. Do not use petroleum based lubricants such as WD40™ on the rollers or doors. Damage will result. Allow caulking to set for 24 hours minimum.

Your **Tub-Master** door is now fully installed and will provide years of service!

Thank you for selecting **Tub-Master**.

# "IT/IS" Folding Door Installation Instructions

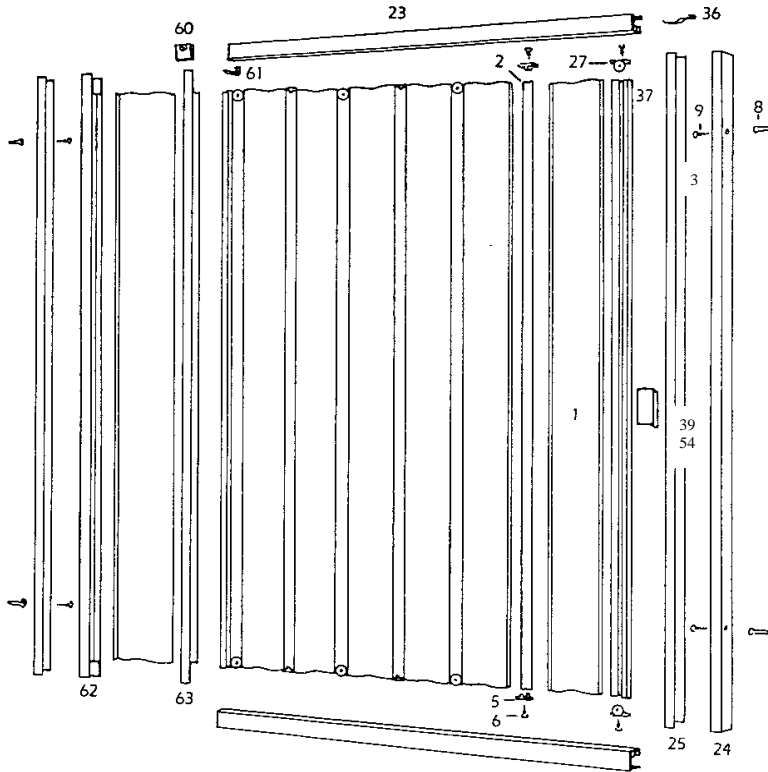

IT/IS PART NO.	DESCRIPTION
1	Panel
2	Hinge
3	Metal Lead Post
5	Panel Stop
6	Panel Stop/Roller Bracket Screw
8	Installation Plug
9	Installation Screw
23	"I" Top and Bottom Track
24	Plastic Wall Jamb
25	"I" Metal Snap Jamb
27	"I" Roller
36	Wedge Lock
37	Handle and Screw
39, 54	Handle and Screw
60	"I" Lock Block
61	Wheel Stop Bracket
62	Fixed Panel Snap Jamb
63	Fixed Panel Post

**TOOLS:** 3/16" Masonry Drill Bit    Hammer  
 Electric Drill    Hack Saw  
 Tape Measure    Screwdriver  
 Silicone Caulk    Center Punch

### MAINTENANCE

All Tub-Master ("TM") products should be rinsed & wiped off immediately after cleaning. TM recommends using a diluted bleach solution at 5% concentrate or less. Commercial, household, & "leave-on" spray cleaners can harm finish & impair safety. Non-recommended cleaners on the market may be appropriate; if you should use a non-recommended cleaner, use cleaning agents compatible with product material. TM doors are made from ABS resins; the crystal silver/gold lines are made from butadiene styrene. *Use of non-recommended cleaners will void warranty.* For more information: Call Consumer Info. Line at (407) 898-2881, ext. 119 or go to TM website at [www.tub-master.com](http://www.tub-master.com).

### LIMITED WARRANTY (SHORT FORM)

All Tub-Master ("TM") shower and tub doors are warranted to be free from defects in material and workmanship for a period of (2) two-years from date of purchase. TM doors for commercial use have a (1) one-year warranty. Replacement is limited to supplying a replacement door and/or parts and does not include cost of shipping, installation, or other associated costs. Warranty is void if door is altered or is maintained with improper cleaning agents or chemicals. For products distributed but not manufactured by TM, please refer to the manufacturer's warranty. Please see TM Maintenance & complete Warranty for further information. [www.tub-master.com](http://www.tub-master.com)

## WARRANTY REGISTRATION CARD (register on-line at [www.tub-master.com](http://www.tub-master.com))

NAME: \_\_\_\_\_ AGE: \_\_\_\_\_

ADDRESS: \_\_\_\_\_

CITY: \_\_\_\_\_ STATE: \_\_\_\_\_ ZIP: \_\_\_\_\_

PLACE OF PURCHASE: \_\_\_\_\_ PRODUCT/MODEL NO. \_\_\_\_\_  
 (example: FS31 WH WH CHR, S1218WH-D-H)

METHOD OF INSTALLATION:  do-it-yourself  installer  other: \_\_\_\_\_

INSTALLATION TIME: \_\_\_\_\_ DATE: \_\_\_\_\_ (month/year)

HOW DID YOU HEAR ABOUT PRODUCT?  store display  friend/family  salesperson  
 catalog  other: \_\_\_\_\_

COMMENTS: \_\_\_\_\_  
 \_\_\_\_\_  
 \_\_\_\_\_

MAIL TO: Tub-Master, 413 Virginia Drive    Orlando, FL 32803    TOLL-FREE FAX: 800-327-1911